



tipper

alba.

tipper

Design by: R&D Alba
Sefano Bettio



Tipper utilizza
tecnologia brevettata
*Tipper utilizes
patented technology*

IT: 12019000006990
EU: 3741253
US: US 11,033,101 B2



Tipper è certificato
ANSI/BIFMA
*Tipper is certified
ANSI / BIFMA*

features & certifications





Tipper Pro

Tipper Duo



Tipper Classic



The Tipper collection



Tipper è la nuova proposta di **struttura per tavoli** nata per offrire un vero valore aggiunto al mercato.

Progettato per l'ambiente **Conference** garantisce **vantaggi funzionali distintivi**: vanta infatti sia **totale accatastabilità**, grazie al **piè in chiusura inclinata** sia **massima maneggevolezza**, grazie alle maniglie bloccasblocca poste su entrambi i lati. Il traverso può infatti essere ribaltato con una sola mano.

Tipper è inoltre adattabile a **qualsiasi top standard** presente sul mercato, grazie alle sue **tre lunghezze di traverso**: 1.165 - 1.465 - 1.765 mm.

La collezione Tipper offre **tre diverse versioni di gamba**: Duo, Pro e Classic. Disponibili in **due diverse larghezze** (600mm - 750mm) e in diverse finiture e colori.

Tipper is our new table structure created to offer real added value to the market.

Designed for Conference environments, it delivers distinctive functional advantages: it can be nested perfectly courtesy of the foot which pivots as the table is closed, and it provides superb ease of handling, thanks to the locking handles situated on both sides. In fact, the beam can be tilted with just one hand.

Tipper can also be used with any standard top on the market thanks to its three beam lengths: 1.165 - 1.465 - 1.765 mm.

The Tipper collection offers three different leg versions: Duo, Pro and Classic. Available in two different widths (600mm - 750mm) and various finishes and colors.



tipper

leg finishings

Classic leg version



nero black grigio grey bianco white cromato chrome

Pro leg version



nero black grigio grey bianco white

Duo leg version



nero black grigio grey bianco white

colori plastiche
plastic colours



nero black grigio grey bianco white cromato chrome

colori metallo
metal colours

Tre tipologie di gambe: **Classic e Pro**, realizzate interamente in metallo, e **Duo**, realizzata in metallo e tecnopolimero.

Disponibili in diverse colorazioni e dimensioni.

Three types of legs: **Classic and Pro**, made entirely of metal, and **Duo**, made of metal and technopolymer.

Available in different colors and sizes.

Versatilità
Versatility



Configura il tuo tavolo Tipper
Configure your Tipper table



tipper Duo leg version
designed by: Stefano Bettio

tipper

Duo leg version



- finiture gamba
leg finishes
- 3 colori plastiche
3 plastic colours
nero, grigio e bianco
black, grey and white
 - 4 finiture metallo
4 metal finishes
nero, grigio, bianco e cromato
black, grey, white and chrome
 - 3 lunghezze del traverso
3 beam lengths
1165 / 1465 / 1765 mm
 - 2 larghezze gamba
2 leg widths
600 / 750 mm



tipper DUO table assembly

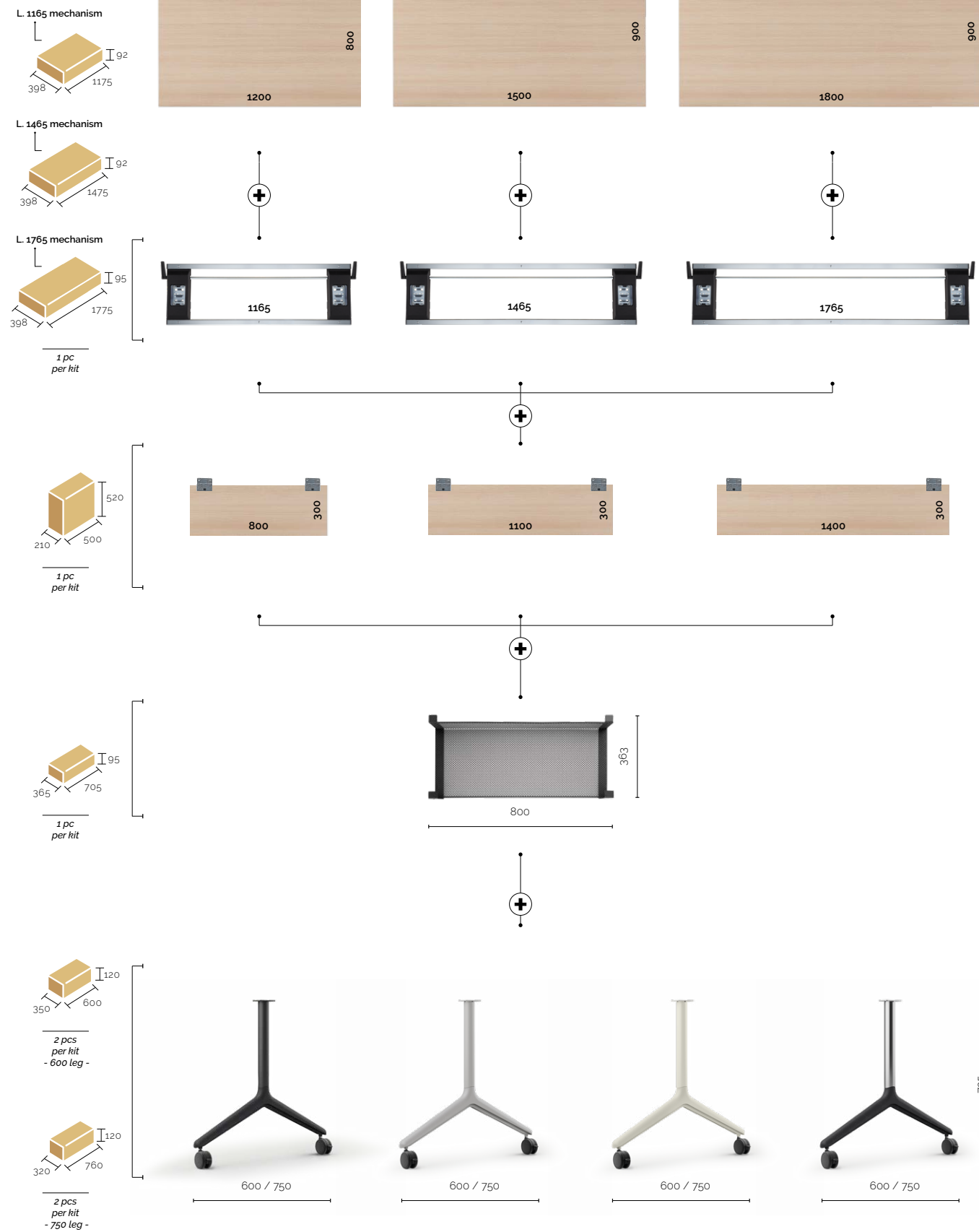



tipper Pro leg version
designed by: R&D Alba

Per unire i tavoli Tipper consigliamo l'utilizzo dell'apposito gancio di unione.
To join the Tipper tables, we recommend using the special table linking device.

tipper

Pro leg version



- 3 finiture gamba
3 finishes of the leg
nero, grigio e bianco
black, grey and white
- 3 lunghezze del traverso
3 beam lengths
1165 / 1465 / 1765 mm
- 2 larghezze gamba
2 leg widths
600 / 750 mm



totale accatastabilità orizzontale
> perfect horizontal nesting



tipper PRO table assembly

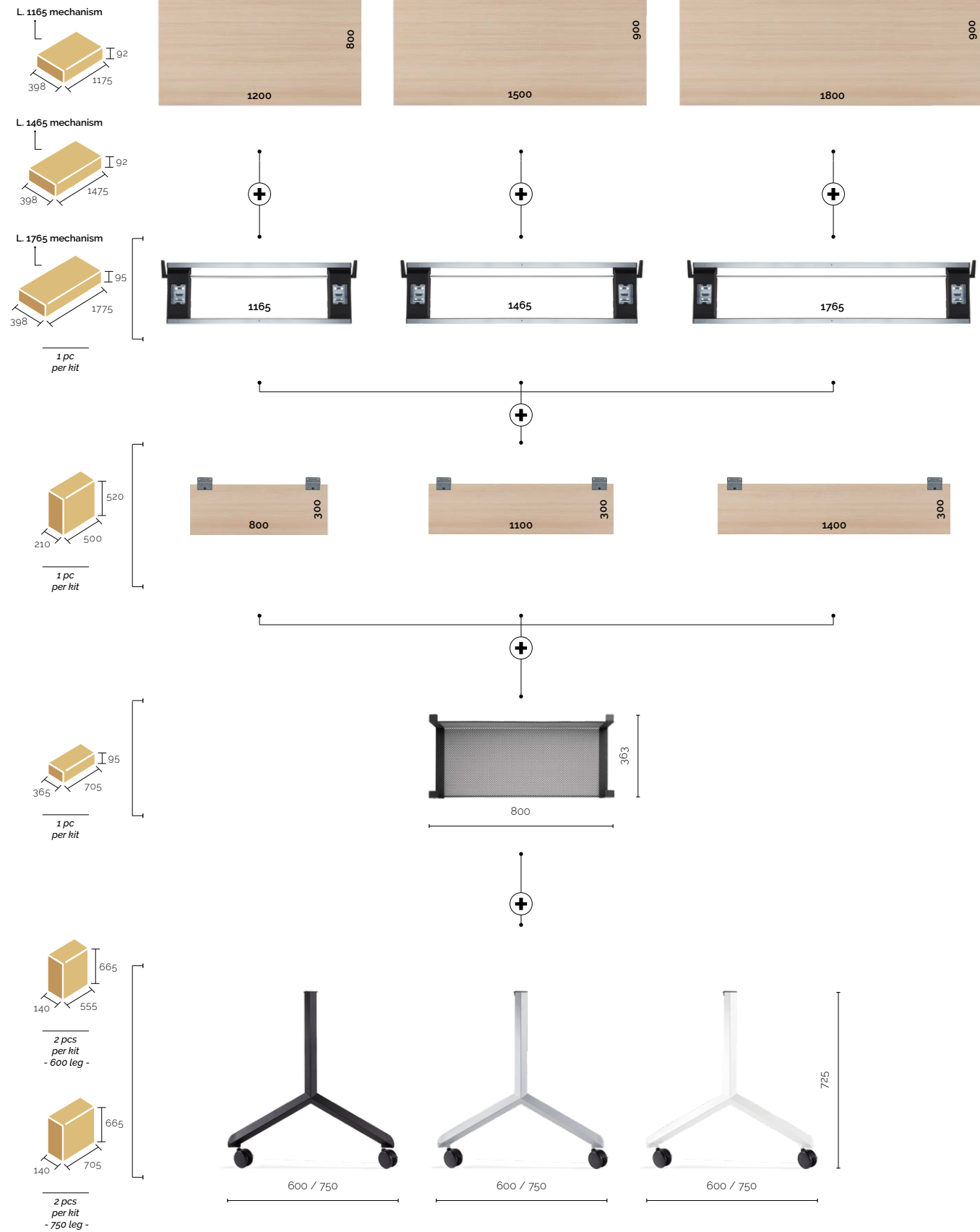

Maneggevolezza e Accatastabilità
Maneuverability and perfect horizontal Nesting



Guarda il video
 Watch the video





tipper classic leg version
designed by: R&D Alba

Per unire i tavoli Tipper consigliamo l'utilizzo dell'apposito gancio di unione.
To join the Tipper tables, we recommend using the special table linking device.

tipper

Classic leg version



4 finiture gamba nero, grigio, bianco e cromato
4 finishings of the leg black, grey, white and chrome

3 lunghezze del traverso 1165 / 1465 / 1765 mm
3 beam lengths

2 larghezze gamba 600 / 750 mm
2 leg widths



1,5 mt > 5 nested tables

totale accatastabilità orizzontale
> perfect horizontal nesting



ruote pivotanti con freno
> pivoting castors with brakes



meccanismo certificato ANSI/BIFMA
> ANSI / BIFMA certified mechanism

accuratezza dei dettagli
> accuracy of details



maniglie blocca-sblocca
> lock-unlock handles

tipper CLASSIC table assembly

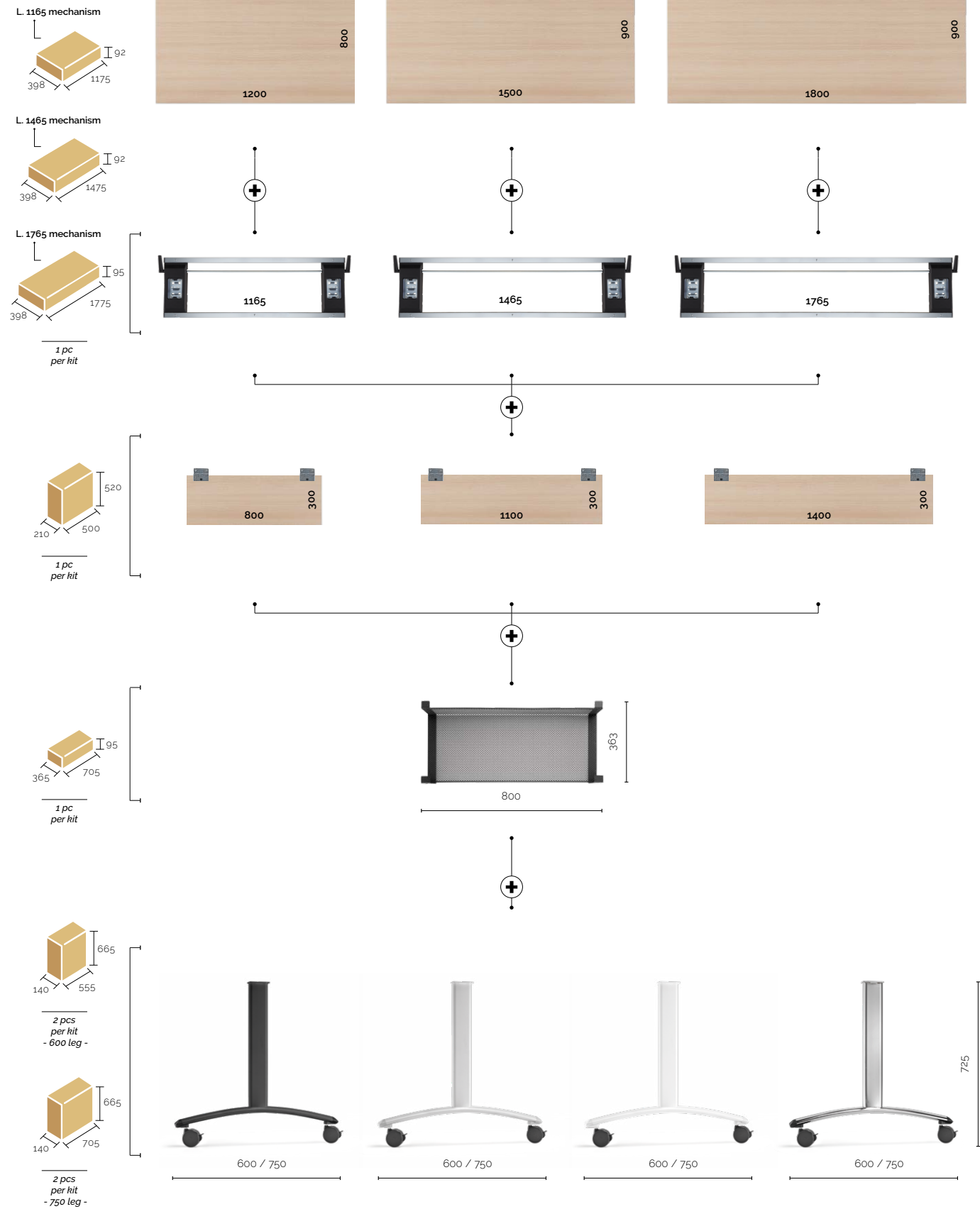

Maneggevolezza e Accatastabilità
Maneuverability and perfect horizontal Nesting



Guarda il video
 Watch the video



tipper

components

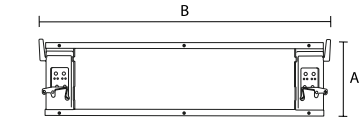
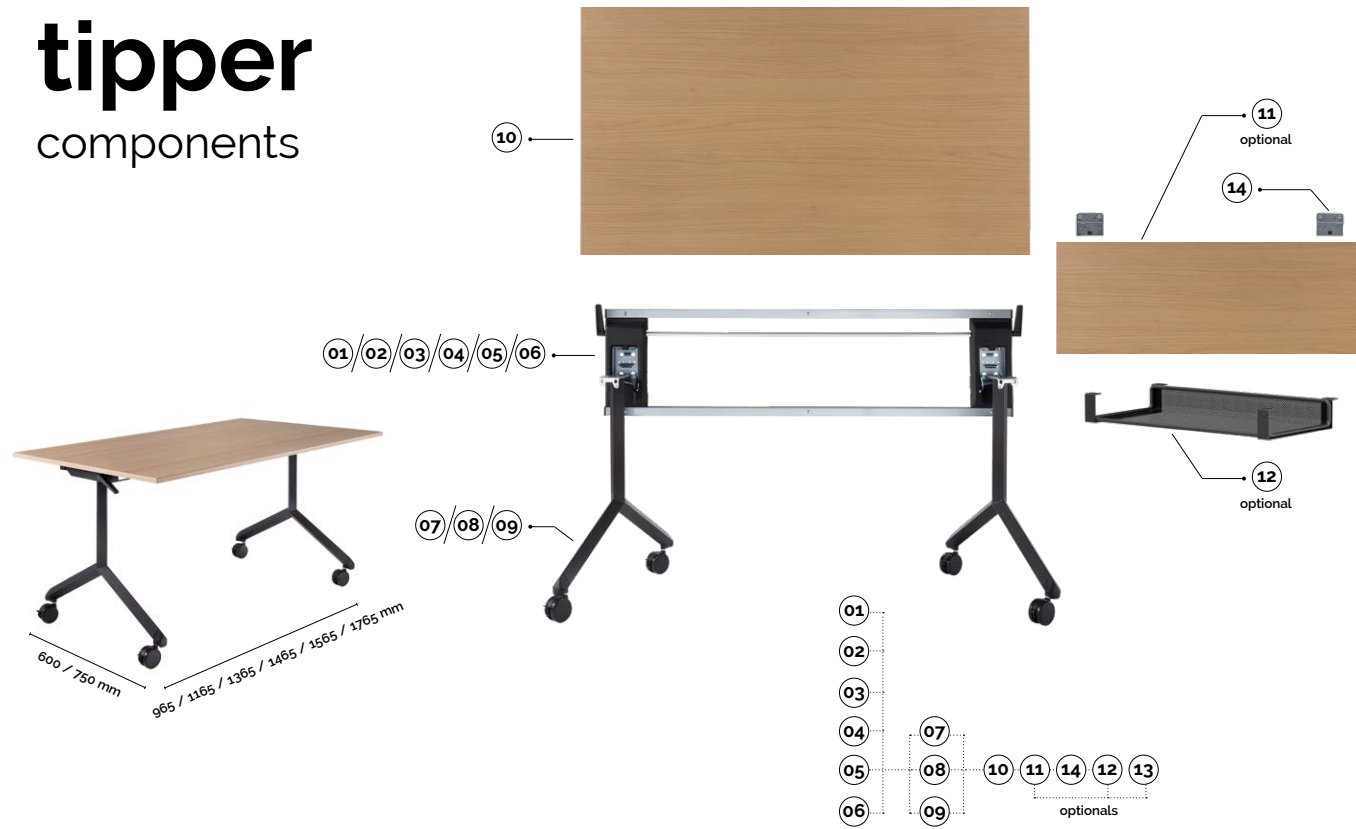

01 02 03 04 05 06

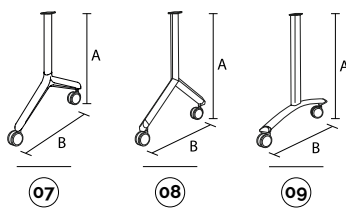

10

code	finishing	q.kit	q.pack	a	b	kg.x1	vol.x1		
110311-660	zincato/zinc	x1	1	360	965	7,18	mc. 0.0543		
110311-007	zincato/zinc	x1	1	360	1165	8,09	mc. 0.0543		
110311-661	zincato/zinc	x1	1	360	1365	8,98	mc. 0.0627		
110311-008	zincato/zinc	x1	1	360	1465	9,30	mc. 0.0627		
110311-662	zincato/zinc	x1	1	360	1565	9,64	mc. 0.0627		
110311-009	zincato/zinc	x1	1	360	1765	10,57	mc. 0.0752		
code	finishing - metal frame	finishing - plastic foot	leg width	q.kit	q.pack	a	b	kg.x1	vol.x1
110303-270	nero/black ral 9005	nero/black ral 9005	600	x2	2	725	600	2,16	mc. 0.0126
110305-270	bianco/white ral 9010	bianco/white ral 9010	600	x2	2	725	600	2,16	mc. 0.0126
110304-270	grigio/grey drylac	grigio/grey drylac	600	x2	2	725	600	2,16	mc. 0.0126
110310-270	cromato/chrome	nero/black ral 9005	600	x2	2	725	600	2,16	mc. 0.0126
110303-273	nero/black ral 9005	nero/black ral 9005	750	x2	2	725	750	2,32	mc. 0.0146
110305-273	bianco/white ral 9010	bianco/white ral 9010	750	x2	2	725	750	2,32	mc. 0.0146
110304-273	grigio/grey drylac	grigio/grey drylac	750	x2	2	725	750	2,32	mc. 0.0146
110310-273	cromato/chrome	nero/black ral 9005	750	x2	2	725	750	2,32	mc. 0.0146
code	finishing	leg width	q.kit	q.pack	a	b	kg.x1	vol.x1	
110303-197	nero rag./black	600	x2	2	725	600	3,55	mc. 0.0328	
110305-197	bianco/white	600	x2	2	725	600	3,55	mc. 0.0328	
110304-197	grigio/grey	600	x2	2	725	600	3,55	mc. 0.0328	
110303-199	nero rag./black	750	x2	2	725	750	3,75	mc. 0.0328	
110305-199	bianco/white	750	x2	2	725	750	3,75	mc. 0.0328	
110304-199	grigio/grey	750	x2	2	725	750	3,75	mc. 0.0328	
code	finishing	leg width	q.kit	q.pack	a	b	kg.x1	vol.x1	
110303-196	nero rag./black	600	x2	2	725	600	3,7	mc. 0.0328	
110305-196	bianco/white	600	x2	2	725	600	3,7	mc. 0.0328	
110304-196	grigio/grey	600	x2	2	725	600	3,7	mc. 0.0328	
110310-196	cromato/chrome	600	x2	2	725	600	3,7	mc. 0.0328	
110303-198	nero rag./black	750	x2	2	725	750	3,9	mc. 0.0328	
110305-198	bianco/white	750	x2	2	725	750	3,9	mc. 0.0328	
110304-198	grigio/grey	750	x2	2	725	750	3,9	mc. 0.0328	
110310-198	cromato/chrome	750	x2	2	725	750	3,9	mc. 0.0328	

tipper

components and optionals

code	finishing	q.kit	q.pack	a	b	c	kg.x1	vol.x1
120307-007	nobilitato rovere / wooden oak	x1	1	1200	800	18	12,50	mc. 0.0173
120307-008	nobilitato rovere / wooden oak	x1	1	1500	900	18	17,50	mc. 0.0243
120307-009	nobilitato rovere / wooden oak	x1	1	1800	900	18	21,00	mc. 0.0291
code	finishing	q.kit	q.pack	a	b	c	kg.x1	vol.x1
120307-010	nobilitato rovere / wooden oak	x1	1	800	300	18	3,20	mc. 0.0043
120307-011	nobilitato rovere / wooden oak	x1	1	1100	300	18	4,30	mc. 0.0059
120307-012	nobilitato rovere / wooden oak	x1	1	1400	300	18	5,40	mc. 0.0075
code	finishing	q.kit	q.pack	a	b	c	kg.x1	vol.x1
113403-403	nero rag./black	x1	1	800	363	95	3,20	mc. 0.0244
113405-403	bianco/white	x1	1	800	363	95	3,20	mc. 0.0244
113404-403	grigio/grey	x1	1	800	363	95	3,20	mc. 0.0244
code	finishing	q.kit	q.pack	kg.x1				
134003-223	nero rag./black	x2	20	0,005				
code	finishing	q.kit						
120307-017	zincato/zinc	x1						

packaging

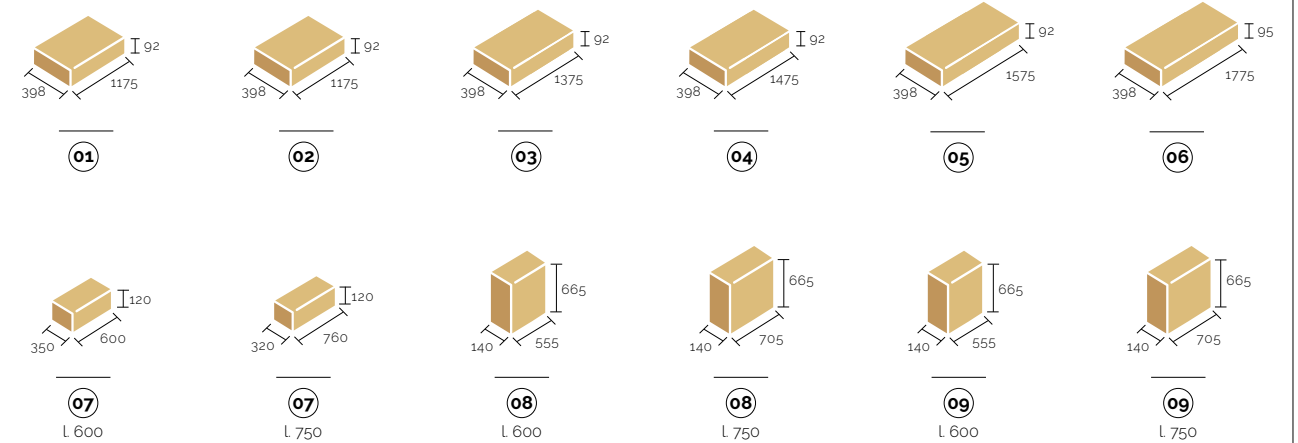

packaging specifications

article	version	q.pack	q.pallet	pallet size
Duo leg	600mm	2	144	800x1200x2300mm
Duo leg	750mm	2	132	800x1200x2300mm
Pro leg	600mm	2	84	1000x1200x2200mm
Pro leg	750mm	2	60	1000x1200x2200mm
Classic leg	600mm	2	84	1000x1200x2200mm
Classic leg	750mm	2	60	1000x1200x2200mm
Mechanism	1000mm	1	50	1140x1200x1800mm
Mechanism	1200mm	1	50	1140x1200x1800mm
Mechanism	1400mm	1	50	1140x1400x1800mm
Mechanism	1500mm	1	50	1140x1500x1800mm
Mechanism	1600mm	1	50	1140x1600x1800mm
Mechanism	1800mm	1	50	1140x1800x1800mm

tipper

optionals — focus on: new table joining hook

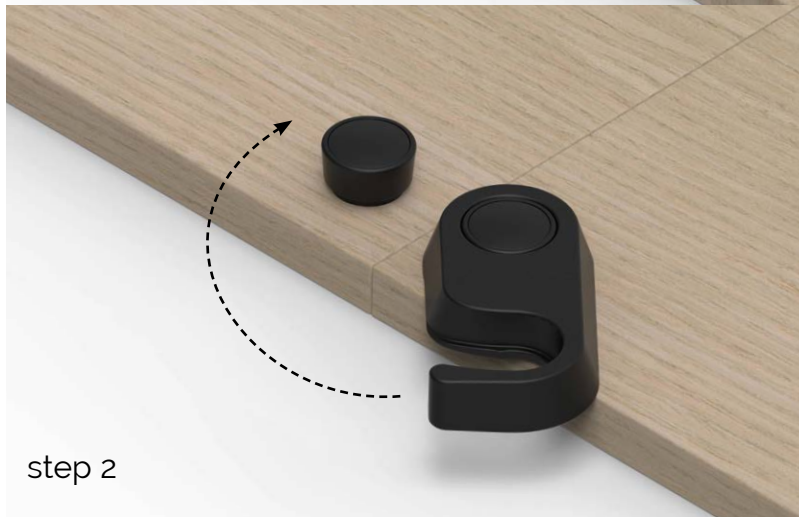
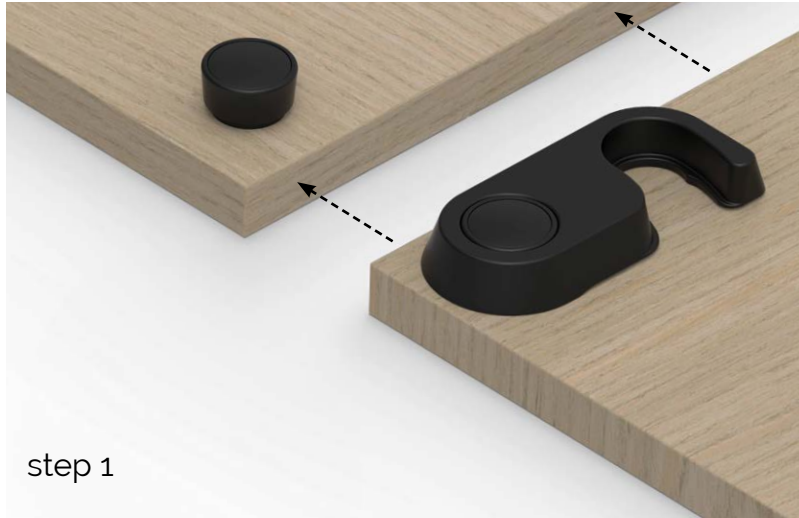

tipper



find out more
Tipper collection

alba.

alba.it

Alba srl

via Boschier, 54/A
31020 San Zenone degli Ezzelini (TV) | Italy
info@alba.it
T. +39 0423 969700